

## POINT CUP

POINT CUP office booth is a sound-friendly 360-degree furniture solution that offers a comfortable space for presentations and video conferences.



### TECHNICAL INFORMATION

**SOCKETS** One electrical socket on the table + 3 sockets in the screen wall.

**SCREEN** Screen wall is suitable for 20-42" screen.  
Screen wall does not include screen nor bracket for it.

**ELECTRICITY CONNECTION** The length of the electric cord for the POINT CUP solution is 3 m.

**MATERIAL DESCRIPTION** Office booth sofa modules with plywood frame, polyurethane foam and fabric upholstery.  
Table with structural paint top and powder-coated steel base.  
Base board painted MDF.  
Screen wall painted MDF and felt from the back.

**OPTIONS** Tabletop with laminate.

**MEASUREMENTS** W2450 x D2350 x H1420 mm  
TOP CUP table Ø900 / H720 mm

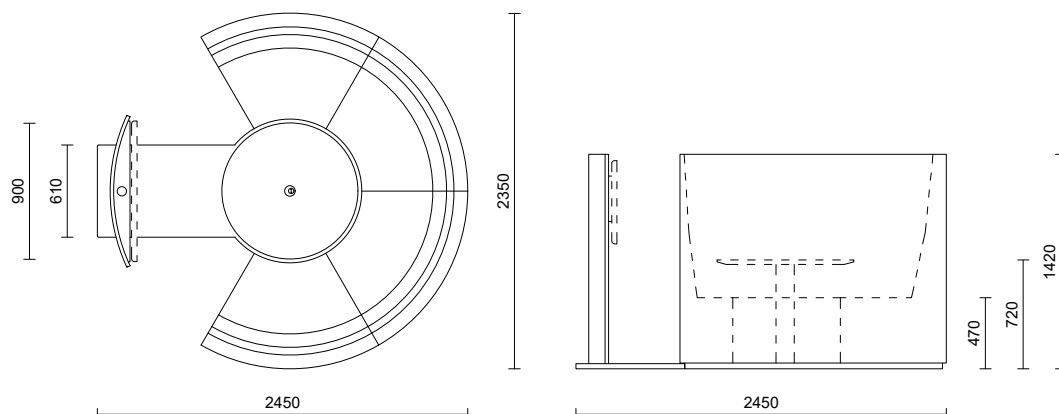



All our materials comply with M1 emission classification.

**UPHOLSTERY FABRIC FOR POINT CUP: WOOLY FROM NEVOTEX | STANDARD PRICE, CATEGORY 1**

Composition: 70% Recycled wool, 25% Polyamide, 5% Other fibers  
 Durability: 150 000 Martindale  
 Lightfastness: 6  
 Crocking: 4-5/wet, 5/dry  
 Sustainability: certified according to Global Recycled Standard (GRS), no. CU1049784GRS-2023-00050154  
 Cleaning: vacuuming and dry cleaning  
 Fire resistant: Yes



2256 Ivory melange    2301 Marsala    1011 Bottle Green    228881 Lapis    1000 Light grey    2279 Ocean    1001 Anthracite



**UPHOLSTERY FABRIC FOR POINT CUP: MAIN LINE FLAX FROM CAMIRA | STANDARD PRICE, CATEGORY 1**

Composition: 70% Virgin wool, 30% Flax  
 Durability: 50.000 Martindale  
 Lightfastness: 5  
 Crocking: 3/wet, 4/dry  
 Sustainability: Complies with EU ecolabel "The Flower", Compostable  
 Cleaning: Vacuuming and dry cleaning  
 Fire resistant: Yes

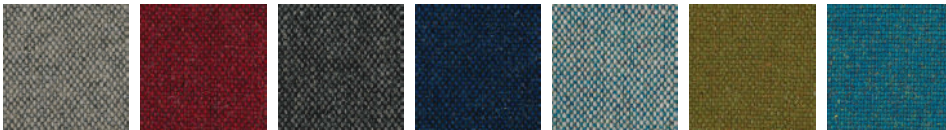

MLF02    MLF14    MLF16    MLF19    MLF24    MLF67    MLF37



**UPHOLSTERY FABRIC FOR POINT CUP: PYTON FROM DELFOS FR | CATEGORY 2**

Synthetic leather  
 Composition: 77% PVC, 23% CO  
 Abrasion / Martindale: dry = 51.200 /cycles, wet = 12.800 /cycles  
 Lightfastness: 5  
 Crocking: 4-5  
 Breathable  
 Fire resistant: Yes / Flame retardant, IMO Certificate

*Cleaning:*  
 Because of its characteristics, clean and care the material frequently, with lukewarm water and a damp cloth, preferably of micro fibre. Soiling may be treated with a mild soap and proceed next to its drying by using a hairdryer or, failing that, a drycloth. It should be avoided that areas that have been treated for cleaning remain wet



0796 Negro    1112 Smoke    0793 Mocca    1168 Cashmere



**UPHOLSTERY FABRIC FOR POINT CUP: GRAIN/2288 FROM GABRIEL | PRICE CATEGORY 2**

Composition: 80% post-consumer recycled polyester / 20% polyester  
 Durability: 100.000 Martindale  
 Pilling: 5  
 Light fastness: 5-7  
 Cleaning: wash or dry cleaning  
 Fire resistant: Yes



61247    62123    64251    66233    68258    60323



**COLOR OPTIONS FOR POINT CUP TABLE**

**STANDARD PRICE, CATEGORY 1**

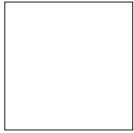

NCS S 0500-N  
Structural

**PRICE CATEGORY 2**

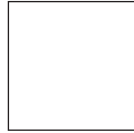

White  
lamine

**STEEL TUBE BASE | STANDARD PRICE, CATEGORY 1**

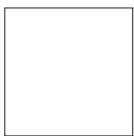

RAL 9016

**FELT FOR CUP SCREEN HOLDER: FULDA FIT FROM FILZFABRIK | STANDARD PRICE, CATEGORY 1**

Composition: 30% Polyamid, 70% Polypropylen  
Static electrical propensity: Antistatic  
Classification for use: Commercial / heavy use  
Fire resistant: Yes

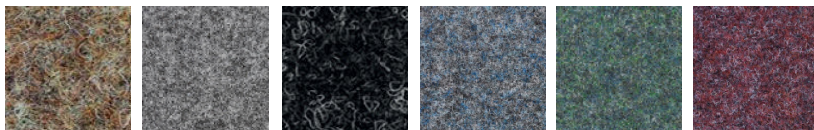

37

61

69

52

85

16

**SCREEN WALL COLOR | STANDARD PRICE, CATEGORY 1**

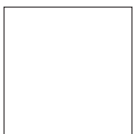

NCS S 0500-N  
Smooth

**BASEBOARD COLOR | STANDARD PRICE, CATEGORY 1**

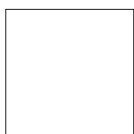

NCS S 0500-N  
Structural